

Adjustable Base # DS0205K5 Wireless

With OKIN Refined Control
and Children Safety Lock

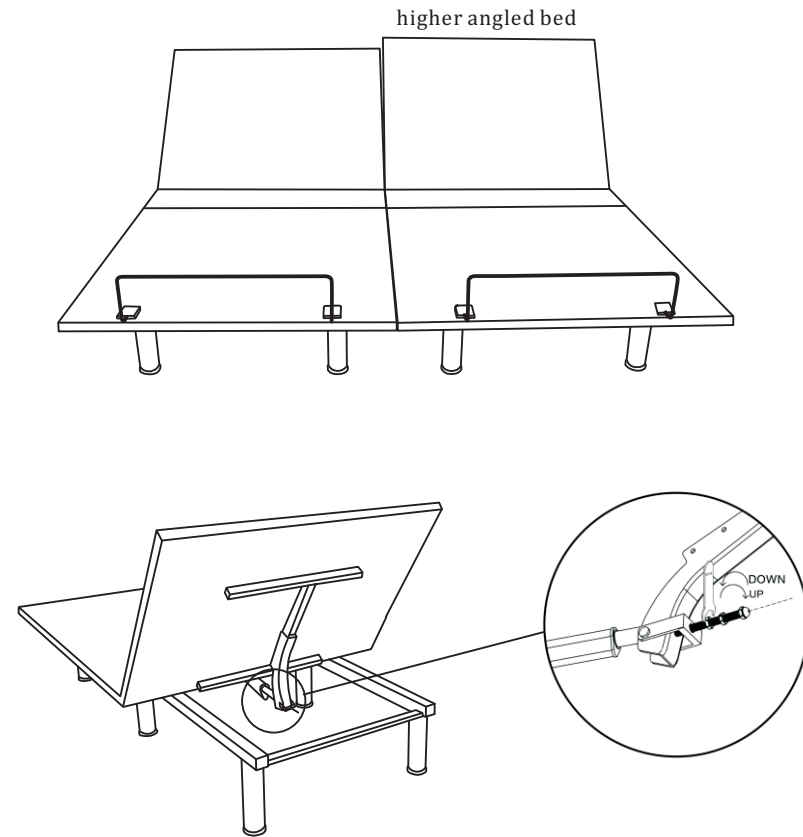
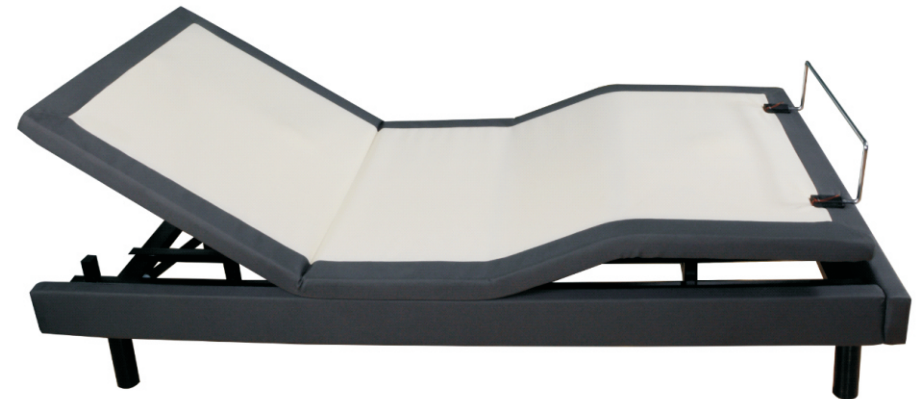

WHEN TWO BEDS DO NOT ALIGN:
on the higher angled bed of the two, use a 19mm
wrench to turn the nuts on the new “LEVEL RIGHT”
counterclockwise to adjust the angle until the higher
angle bed match the level of the lower angle bed and
lock the nut with the reinforce nuts.

The two beds are now aligned. **(For Twin XL Only)**

**For toll-free customer service, call 1-877-386-1373
email us: service@innovasleep.com**

**Please tell us your name, phone, address, serial No.
(found on the foot beam of the bed base),
and the problem when you call/email.**

Owner's Manual



CONTENTS

Advisory

Setup and Installation

Wireless Hand Control

1-2-20 year Warranty

WARNING

Attention: Read the following information before using this product. Failure to use a surge protection device could compromise safety or cause product malfunction and could void the electrical portion of your warranty.

Electrical surges are by far the biggest cause of problems with electrical circuits.

In order to help protect your investment in case of a power surge or outage, use an electrical surge protection device (not included).

WARRANTY WARNING!

Do not open or tamper with the transformer, control box, motors, or remote control (with the exception of battery compartments). The product warranty will be void if these components are tampered with.

SMALL CHILDREN AND PETS:

Immediately dispose of all packing materials as they can smother small children and pets. Do not allow any persons or pets under the bed. Children, convalescents and disabled person should not operate the bed without adult supervision.

HOSPITAL OR CONVALESCENT USE DISCLAIMER:

Adjustable beds are designed and engineered for a life style of in-home comfort and are not intended for hospital use or for a bed-ridden patient on an extended recovery. Adjustable beds are not equipped with bars to help patients get safely in and out of bed and are not intended to be used around tent type oxygen therapy or explosive gases.

PACEMAKER WARNING:

The massage units in this bed produce mechanical vibrations that

motors and massage motors are also excluded. This limited lifetime warranty shall not apply unless the defective part is returned to Innova and Innova receive all service and transportation cost for verification. In years 3-20 years, purchaser shall pay all service and transportation costs related to the replacement of the defective part and required to pay 1/20 of the current replacement cost of the parts times the number of years used.

ADDITIONAL TERMS AND CONDITIONS

This warranty does not apply: (a) to any damage caused by the purchaser; (b) if there has been any repair or replacement of adjustable bed parts by an unauthorized person; (c) if the adjustable bed has been mishandled (whether in transit or by other means), viz, subjected to physical or electrical abuse or misuse, or otherwise operated in any manner inconsistent with the operation and maintenance procedures outlined in the Owner's Manual and this warranty; (d) to damage to mattresses, fabric, cables, electrical cords or items supplied by dealers. (Contact the dealers for warranty information on those items;) (e) if there has been any modification of the adjustable bed without prior written consent by Innova; (f) to costs for unnecessary service calls, including costs for in-home service calls solely for the purpose of education the consumer about the adjustable bed or finding an unsatisfactory power connection; (g) if the recommended weight restriction is not followed (refer to the advisory section of this manual), the warranty will be void; (h) to the use of the adjustable bed base in whatsoever and howsoever manner other than the personal in home use exclusively by the purchaser.

Repairs to or replacement of an adjustable bed base or its components under the terms of this limited warranty will apply to the original warranty period and will not serve to extend such period. The decision to repair or to replace defective parts under this warranty shall be made, or cause to be made, by Innova at its option and in its sole discretion. Repair or replacement shall be the sole remedy available to the purchaser. There shall be no liability on the part of Innova for any special, indirect, incidental, or consequential damages or to any other damage, claim, or loss not expressly covered by the terms of this warranty. This limited warranty does not include reimbursement for inconvenience, removal, installation, setup time, loss of use, shipping, or any other costs of expenses, Innova and/or its service technicians shall not be responsible for moving furniture or any other items not originally attached to the adjustable bed in order to perform service on the adjustable bed. It is the sole responsibility of the purchaser to provide adequate space and accessibility to the adjustable bed. In the event that the technician is unable to perform service due to lack of accessibility, the service call will be billed to the purchaser and the service will have to be rescheduled. Innova makes no other warranty whether expressed or implied, and all implied warranties of merchantability and fitness for a particular purpose are disclaimed by Innova and excluded from this warranty. Some states do not allow the exclusion or limitation of incidental or consequential damages, so the above limitation or exclusion may not apply to every purchaser. This warranty gives the purchaser specific legal rights, and the purchaser may also have other rights, which may vary from state to state. This warranty is valid in all 50 states, Puerto Rico, and Canada.

INNOVA SLEEP PRODUCT

1, 2 & 20 YEAR LIMITED WARRANTY

Innova Sleep Products, Inc. (“Innova”) warrants this adjustable bed to the consumer who is the original purchaser of a new product which was not sold “as is” (the “purchaser”), subject to the terms and conditions set forth herein. This warranty begins on the “warranty commencement date” which is the date of purchase for new unused beds base.

Part Name	Parts warranty period	Labor warranty period
Motor(s)	2 years	1 year
Transformer(s)	2 years	1 year
Remote control	2 years	1 year
Control box(es)	2 years	1 year

During the Parts warranty period, there will be no charge for parts.
During the Labor warranty period, there will be no charge for labor.

If repair is needed during the warranty period, the purchaser will be required to produce a sales receipt/proof of purchase evidencing the date of purchase, the amount paid and the place of purchase. If no such sales receipt/proof of purchase is produced, full amount of charges for labor and the parts shall be paid before any services could be rendered.

FULL 1 YEAR WARRANTY

This adjustable bed is warranted against defects in the workmanship or materials for a period of one (1) year from the warranty commencement date. Upon notice during the first year after the warranty commencement date, Innova will repair or replace (at no cost to the purchaser) any defective adjustable bed base part with new or refurbished parts, and Innova will pay all authorized labor and transportation costs associated with the repair or replacement of any parts found to be defective. When the adjustable bed at hand is found to be DAMAGE, not DEFECT, all costs incurred to inspect and /or correct the requested issue will be the financial responsibility of the requesting party.

2 YEAR LIMITED WARRANTY

During the second year from the warranty commencement date, upon receipt of notice, Innova will replace any adjustable bed base part found to be defective with new or refurbished parts. Purchaser shall pay all service and transportation costs related to the replacement of the defective part. This limited two (2) year warranty shall not apply unless the defective part is returned to Innova and Innova receive all service and transportation cost for verification.

20 YEAR LIMITED WARRANTY

Upon written notice during the third year through the 20th year from the warranty commencement date, Innova will replace, upon terms and conditions set forth in this paragraph, any mechanical bed base parts found to be defective. Electronics, electrical components, drive

may activate a special sensor in your pacemaker that detects motion. This can fool the pacemaker into “thinking” you are engaged in some sort of physical activity and require a faster heart rate. You may experience a sensation similar to when you are exercising. Consult your physician for further information.

PRODUCT RATINGS:

The bed lift motors are not designed for continuous use of more than 2 minutes in an 18 minutes period, or approximately 10% duty cycle. Any attempt to circumvent or exceed this rating will shorten the life expectancy of the product and may void the warranty.

WEIGHT UNITS:

The limitation for this adjustable bed is 750 lbs. The bed will structurally support these weights, provided weight is evenly distributed across the head and foot sections. This product is not designed to support or lift this amount in the head or foot section alone. Exceeding this weight restriction could damage the bed and/or cause injury and void the warranty. Enter or exit the bed in a flat position and do not sit on the head or foot sections while in the raised position.

LIFTING AND LOWERING MECHANISMS AND MASSAGE UNITS:

It is normal for the raising and lowering feature on this bed to emit a minimal humming sound during operation. The massage feature creates a vibrating hum during operation and the resonance will increase accordingly with a higher intensity motor setting.

LOCATION ENVIRONMENT:

The level of sound experienced in a room is directly related to the environment within that location. In a room with hardwood floors and the massage units turned on, a vibrating noise can be noticeable. To reduce the resonance, place a piece of carpet or rubber casters cups under the legs. The rubber caster cups also prevent the bed sliding when located on smooth or hard surface flooring.

TO REDUCE THE RISK OF SHOCK, BURNS, FIRE OR INJURY:

Make sure the base is in a flat position and the vibrating motors are turned off before unplugging the bed base from the power source. Always unplug the base from the electrical outlet before cleaning or servicing the base. If the cord or plug is damaged, discontinue use of the bed base. Contact a qualified service personnel for examination and repair.

FCC COMPLIANCE:

This device complies with part 15 of the FCC Rules for residential use. Operation is subject to the following two conditions: (1) This device may not cause harmful interference, and (2) this device must accept any interference received, including interference that may cause undesired operation.

Radio Frequency: 2.4 GHz

EMERGENCY BATTERY BACKUP:

In the event that the base is stuck in an articulated position during a power outage, the battery backup in the transformer can be used to return the base to flat position. To use the battery backup, install two 9-volt alkaline batteries into the battery backup transformer (fig 1). Press the "Emergency Lowering" button on the control box (see fig 9) to return the bed to the level position. Alternately, you can use the remote control to return the bed to the level position. First, press the "foot down" button. And then, press the "head down" button. When using the battery backup, pressing the "flat" button on the remote will not return the bed to the level position.

Please note that batteries are for backup only and are not to be used for normal operation of the bed base.



Figure 1
4-12

INNOVA
SLEEP SYSTEMS

OKIN Wireless Remote #DS0205K5 Adjustable Bed

Preset Position Buttons Memory A, Memory B, ZG.

1. Press the "FLAT" button to return the bed to flat position.
2. Adjust the head and foot to desired positions.
3. Press the "TIMER" button until back light flashes, then press "Memory A" / "Memory B" or "ZG" button.
4. You can reset the 3 position buttons by repeating the above steps.

Head Buttons
Use to raise or lower the head of the bed.

Zero Gravity button
Preprogrammed for optimum comfort and relaxation position

Memory Button A

Timer Button
Use to set the desired time, then press the head and/or foot Massage buttons to start the massage. Also a stop button when the massage is on.

Head Massage Buttons
Use to increase or decrease the massage intensity of the head

Massage Type Button
Offer three massage actions : Pulse, Wave & Constant

Children Safety Lock buttons
For children safety reason, Press these two buttons simultaneously till LED flashes to lock.

Raise/Down Buttons
Use to raise or lower both head and foot at the same time

Foot Buttons
Use to raise or lower the foot of the bed.

Flash Light Button
Use to turn on and off the flashlight.

Flat Button
Press to return to flat position





Memory Button B

Under Light Button
Use to turn on the safety light, which will stay on for 5 minutes and then turn off automatically





Foot Massage Buttons
Use to increase or decrease the massage intensity of the foot.

Children Safety Unlock buttons
For children safety reason, Press these two buttons simultaneously till LED flashes to unlock.

Deactivate children safety lock:

- 1) Unlock the children safety lock by pressing the  button and the  button simultaneously.
- 2) Deactivate the children safety lock function by pressing the  button and the  button simultaneously.

Activate children safety lock

Activate the children safety lock function by pressing the  button and the  button simultaneously or by pressing the  button and the  button simultaneously.

USING SAME REMOTE:

The bed base is designed to allow two twin X-Long bases to become an Eastern King base and two Split-Cal-King bases to become a Cal-King base. Owner can use the same remote to control two side by side bed bases by Connecting the two control boxes with the cable. Plug one side of the cable into the “CYNCHRO CNTL” on the side of the control box and plug another side into the “CYNCHRO CNTL” on the side of another control box, then you can connect two control boxes (See figure 8&9). It is important that the two control boxes expected to work synchronously must be still configured differently to pair with the different remote control with different DIP-Switch position. Do not pair both control boxes with the same remote control, Each remote must have a different DIP-switch setting.



Figure 8

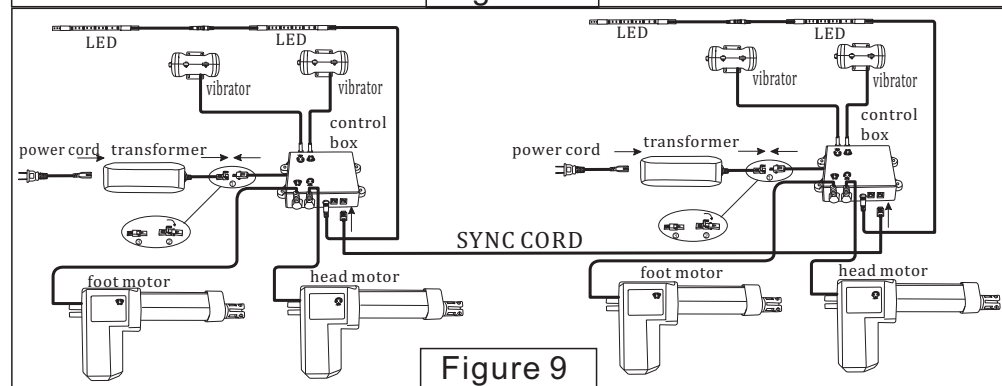

Figure 9

The synchronise cord is not on the full warranty list. We will replace the it for free if the defective one is mailed back.

Setup is now complete. Enjoy.

SETUP and INSTALLATION
Important: We strongly recommend two able-bodied adults setup and assemble this product.

Step 1:

Check and verify all parts are included before discarding any packing materials.

All electronics and components that need to be installed are located in boxes under the base or attached to the frame.

- A) Wireless Remote Control (1)
- B) Mattress Retainer Bar (1)
- C) Legs -9" (4)
- D) Power Cord (1)
- E) Extension Cord (1)
- F) Transformer with emergency battery backup (1)
- G) Control Box (1)
- H) Sync Cord (1) (for Twin XL and SPLIT CK)

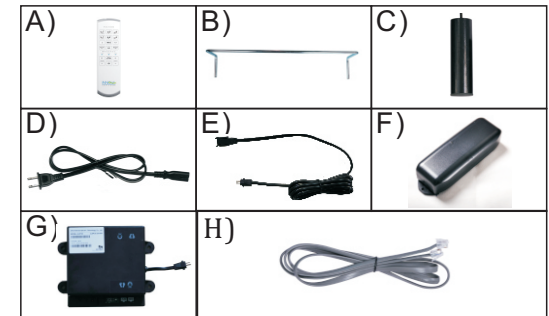

Step 2:

With the help of your able-bodied assistant, place carton on floor with arrows point downwards.

Step 3:

Connect the Transformer “F” to Control Box “G” : The Control Box is the Black Box attached to the bottom of the bed . Connect one side of Extension Cord “E” with the Control Box “G” and plug another side of Extension Cord “E” into Transformer “F” . Extend the Power Cord “D” plug into Transformer “F” . (See Figure 2)

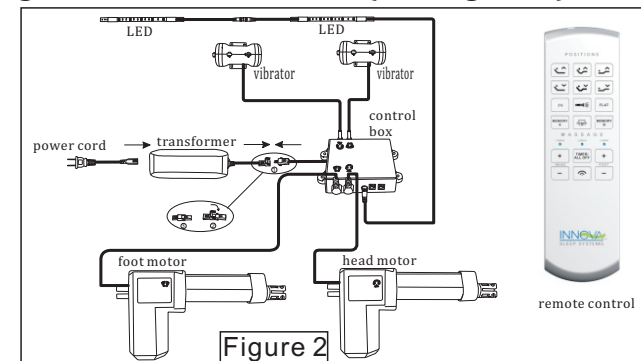

Figure 2

Step 4:

Locate the Wireless Remote control and insert 3 AAA batteries (See Figure 4) . Push the DIP SWITCH on the remote to a certain position (different from the position on the other remote) , if you have more than one adjustable bed .

Step 5& 6:

Plug electrical cord into a grounded electrical outlet.

Using the Wireless Remote, push the Foot Up Button and Massage Intensity decrease Button until LED lights flash to unlock , then push the Head Up button, Foot Up button , the vibrating motor and Flat Button for a momentary test of the Wireless Remote. Please note that the actuator is a gravity down motor , it needs weight to come down . If the motor is working quickly let go of the button and skip to step 8.

Step 7:

Synchronize the remote with the control box. First find the black box mounted under the bed. Press the black LINK BUTTON until the LINK LED is flashing , then press HEAD UP and FOOT UP buttons simultaneously until the back light on remote control is flashing . The adjustable bed should be working after matching the remote with the control box . Press the Head Up button , Foot Up button , the vibrating motor and Flat Button to test . We strongly recommend that each control box must be matched with different remote controls where the DIP SWITCH positions are different . Do not match both control boxes with the same remote control .Each remote must have a different DIP SWITCH setting . There is a red Emergency Lowering button on the control box . When the remote control is not working , pressing it adjusts bed to the level position (See Figure 5) .



Figure 4

6-12

Figure 5

Step 8:

-Unplug the Power Cord.

-Install the four legs firmly into the base of the frame. The legs screw into the threaded holes in each corner of the adjustable base frame. (See Figure 3) .

Do not over tighten.

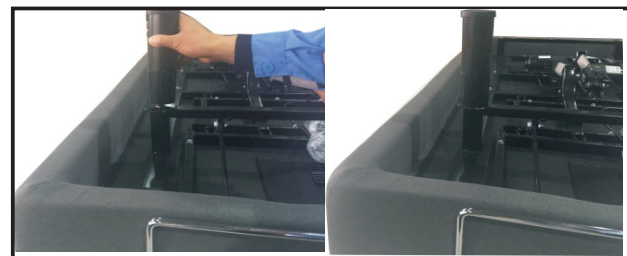

Figure 3

Step 9:

With the help of your able-bodied assistant , carefully lift the adjustable bed frame and set it in place upright on its legs . Excessive pressure may damage the legs. Remove all protective plastic covering. Note: check and make sure that all power cords clear and do not interfere with any Adjustable Bed Mechanisms; Dispose of covering properly to avoid injury.

Step 10:

Note : The Mattress Retaining Bar is mounted upside down for shipping only . Remove the Mattress Retaining Bar on the foot of the bed and turn the bar upright and re-install by carefully aligning and pushing the bar into place . Insert the retaining clips to secure the bar into place . (See Figures 6 & 7 .) The retaining bar is to prevent the mattress from slipping out the base and should not be used as a handle of the base. Using as a handle will damaged the retaining bar holders. Screws come out from the retainer bar holders will be considered as a damaged part and not a defective part and is not covered by the warranty.



Figure 6

7-12

Figure 7